

## Air Handling Unit

Comfort Air Handling Units

Air Handling Units with Plate Type Heat Recovery Unit

Air Handling Units with Rotary Type Heat Recovery Unit

Hygienic Air Handling Units

Package Hygienic Air Handling Units (PHS)

Air Handling Units Fuelled With Natural Gas (DGS)

Pool Dehumidification Air Handling Units

Duct Type Air Handling Units (Vertical or Horizontal Type)

Shelter-Ventilating Units (SKS)

The logo for VENTAS, featuring the word "VENTAS" in a bold, teal, sans-serif font. A stylized white fan or turbine icon is integrated into the letter "A".

VENTAS Isıtma, Soğutma, Enerji Sistemleri, İnşaat Sanayi ve Ticaret Anonim Şirketi; has been established in 2011 for production, consulting, project preparation and equipment supply in heating, cooling, air-conditioning and energy efficiency areas. VENTAS, which is established on top of twenty years of know-how and experience of its founders in the aforementioned sectors, is serving at its İstanbul Hadimkoy and Catalca production centres.

The product portfolio of HVAC market's new brand VENTAS includes, hygienic air handling units, comfort air handling units, high-efficiency heat-recovery ventilation units, fan coil units, exhaust fans with cabinet, supply fans with cabinet, duct type fans, roof type fans, fire smoke removal fans, trench heaters, roof top package air conditioning systems (water cooled, air cooled, gas-fired, heat recovery etc.) units.

Having ISO 9001, CE, TSEK, GOST-R and EN 1886 certificates and benefiting all advantages of modern high technology, in VENTAS production centres, high quality and durable products are manufactured by a dynamic and experienced expert team with a meticulous and neat workmanship, and a solution oriented approach.

VENTAS brand's main principles are to serve its customers as a high quality solution partner and to provide excellent service with a dynamic structure both in pre-sales and after-sales.

Having reached a fast and continuous growth track since it has been established, VENTAS has managed to become a well-known company in heating, cooling, air-conditioning and energy efficiency sectors throughout the country. Moreover, the Turkish brand VENTAS has penetrated its excellent and high quality products into international markets in a very short time frame, and offered a complete product supply chain to these markets through its wide dealer and service structure.

Paying the utmost attention in its products to energy efficiency, endurance, reliability, sustainable technology and competitive price policy, VENTAS offers to be the corporate solution partner of all investors and mechanical construction companies in Turkey and all over the world, and shares its dynamic vision, renewed and developed continuously, with all its customers.



## General Specifications

With an air flow range from 1000 m<sup>3</sup>/h to 100,000 m<sup>3</sup>/h, Standard KS series of Air Handling Units are manufactured in three different panel thickness of 28mm, 43mm and 63mm.

EUROVENT Certified VKS Series are manufactured with 63 mm panels.

Besides, solutions are offered for application areas such as hospitals (operation and clean room), pharmaceuticals factories, food production factories, chemical production facilities and for similar applications with hygienic air handling units produced in two different panel thickness of 43mm and 63mm.

Within air handling units, production can be made with different filling materials such as rock wool, glass wool or polyurethane.

Sheet metal thickness between 0.80mm and 1.2mm is available for alternative air handling units.

For panel production material, VENTAS provides galvanized, rustproof, aluminium and PVC coated sheet options. Moreover, RAL 9002 painted metal sheets are used at the outer part of units.

Special aluminium profiles are used at the outer frame of air handling units. Profiles have a custom and closed design in order to reduce the internal pressure losses as much as possible and prevent from pollution that can be produced within the devices.

Corner and omega parts connecting outer frame system are designed in accordance with the structure of profiles and strengtheners and manufactured out of heat-resistant glass-strengthened composite material.

Panels are manufactured in sandwich structure with double sides. Within panels, rock wool insulation material with 70kg/m<sup>3</sup> density is used as sound and thermal isolation filling material. Moreover, glass wool and polyurethane insulation materials are also available optionally. At connection points of panels and outer frame, impermeable tight seals from EPDM material with custom surface design are used.

Within VENTAS air handling units, air adjustment dampers with aerodynamic wings are used which work with hidden geared impulsion system. Damper wings and frame are manufactured from aluminium profile. Gear and bearing systems are produced with a rigid composite material resistant to heat, impact and dust. There are special seals between damper wings in order to guarantee air impermeability.



# Air Handling Unit

## General Specifications

Air handling unit's ventilator or aspirator units are produced in standard cellular structure. While ventilator and aspirators can be chosen as forward curved blades or backward curved blades, radial single/double suction fans balanced statically and/or dynamically, they can also be designed with plug-fan. Electrical motor of fans are mounted on to the same chassis. In order to prevent the vibration that can be occurred especially within this chamber to the other part of the air handling unit, rubber-based or elastic (with spring) vibration isolator is used at an amount and size dependent on the capacity, size, fan and motor cycles of the unit.

Pulleys used in fans and motors are V belt pulleys with clamping rings in accordance with DIN 2211 and TS 148 norms. Pulleys are formed in two parts. That second part can be mounted without a need for a hardware after the first part is mounted in fabric to the fan and motor spindle makes specifying the pulley size very easy when desired. In order to transfer power between motor and fan pulleys, narrow V-belts (complying with TS 198/40 DIN 7753/1) or classical V-belts (complying with TS 198/1 DIN 2215) are used. Moreover, there is a belt stretching mechanism for adjusting the belt tightness between the fan and motor to the suitable level.

Mounting frames are designed for different filter classes used together with air handling units for several different purposes. Thanks to this design, filters can be placed very easily into their sockets with spring systems. With this design, any possible by-pass that can be occurred at filters are reduced to minimal levels. G3-G4 class filters used as front-side filters, have galvanized frames, and with galvanized string connections, they are mounted with increased resistance to air flow.

Bag filters with different classes are used as second-level filters in air handling units. Moreover, bag filters are used as pre-filters for hygienic air handling units. Bag filters can be chosen out of F5 to F9 classes and applied. In air handling units, rigid filters can be used as the last filter at between classes F5 to F9 upon need. In order to filter specifically the undesired smell at air handling units, carbon imbued panel or active carbon filters with cartridge are used.

Heating and cooling coils used in air handling units are manufactured as aluminium fin/steel collector or steel fin/steel collector depending on fluid features. All coils are subject to hydrostatic tests before mounting. In order for easy maintenance and mounting, coils are designed with special sliding mechanism. In air handling units with cooling coils, rustproof condensation pan and polypropylene drop eliminate (complying with DIN 7728 standards and resistant up to 130 °C) is designed and produced as standard.

Optionally, steamy and watery evaporating humidifier units can be produced in standard cell structure. In order to prevent water drops, that formed during humidification within the cell, to get over to the surrounding or to the other parts of the unit, polypropylene drap eliminates are used and mounted to the inner part of the cell.

Silencer modules are manufactured in standard cell structure. Rock wool or glass wool is used in silencer coulisses. Two sides of the silencer's coulisse in contact with air are coated with fiber glass material. Different numbers of coulisses are used within the cell depending on capacity and size.



### Air Handling Unit Models Capacity Graph

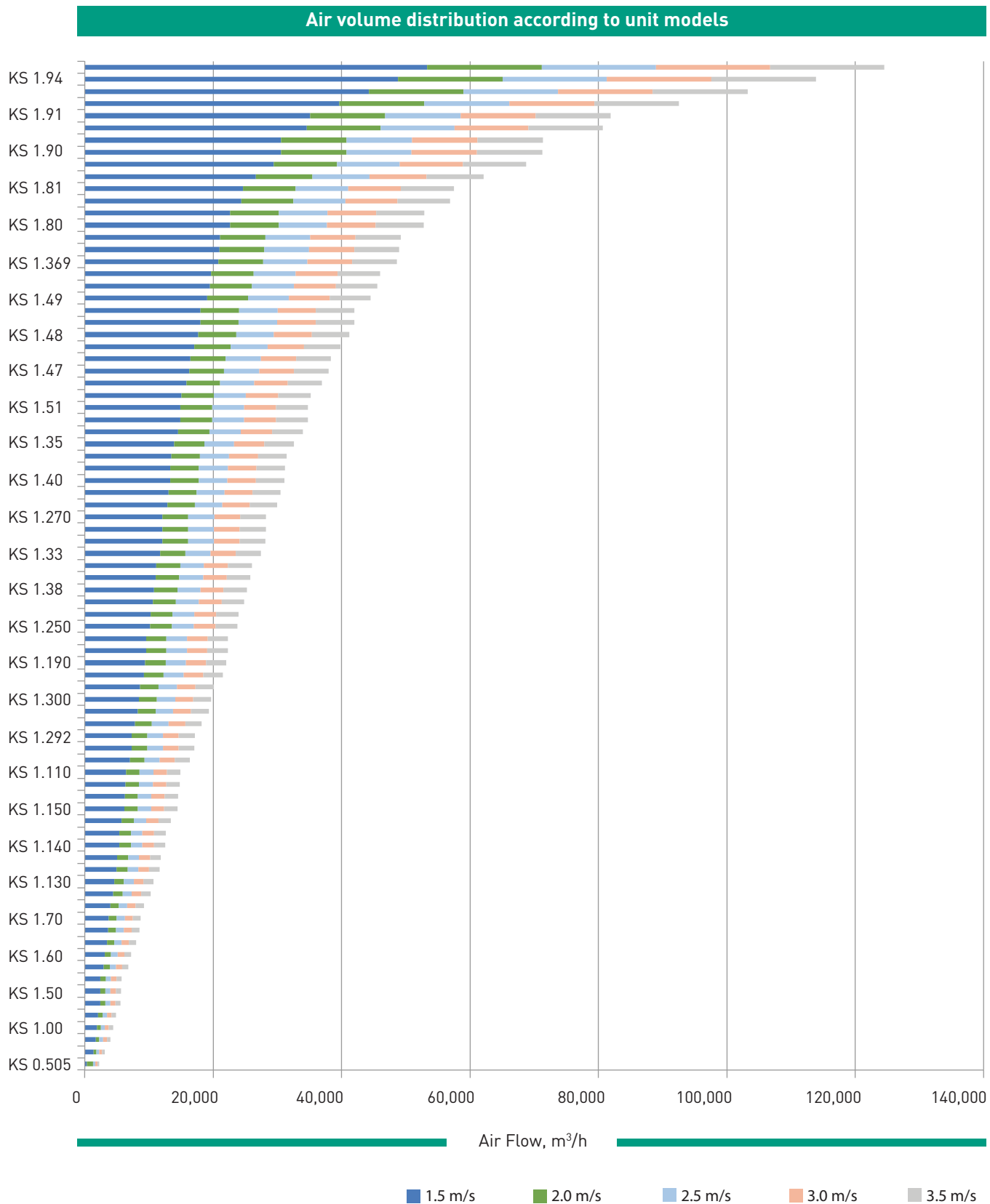

# Air Handling Unit

## Air Handling Unit Models Size Table

SIZE NAME	H	B	1.5 m/s	2 m/s	2.5 m/s	3 m/s	3.5 m/s
KS 0.505	535	535	325	1,300	1,625	1,950	2,275
KS 0.50	535	700	1,345	1,793	2,241	2,689	3,137
KS 0.51	535	865	1,714	2,286	2,857	3,429	4,000
KS 1.9821	865	865	3,078	4,103	5,129	6,155	7,181
KS 0.52	535	1030	2,084	2,779	3,474	4,168	4,863
KS 0.53	535	1195	2,454	3,272	4,090	4,908	5,726
KS 1.00	700	700	1,879	2,506	3,132	3,758	4,385
KS 1.10	700	865	2,396	3,195	3,993	4,792	5,591
KS 1.20	700	1030	2,913	3,884	4,855	5,826	6,796
KS 1.30	700	1195	3,430	4,573	5,716	6,859	8,002
KS 1.40	700	1360	3,946	5,262	6,577	7,893	9,208
KS 1.50	865	700	2,414	3,218	4,023	4,828	5,632
KS 1.60	865	865	3,078	4,103	5,129	6,155	7,181
KS 1.70	865	1030	3,741	4,989	6,236	7,483	8,730
KS 1.80	865	1195	4,405	5,874	7,342	8,810	10,279
KS 1.90	865	1360	5,069	6,759	8,448	10,138	11,828
KS 1.100	865	1525	5,733	7,644	9,555	11,466	13,376
KS 1.110	865	1690	6,397	8,529	10,661	12,793	14,925
KS 1.1200	1030	700	2,948	3,931	4,914	5,897	6,880
KS 1.120	1030	865	3,661	4,881	6,102	7,322	8,542
KS 1.130	1030	1030	4,570	6,093	7,617	9,140	10,663
KS 1.140	1030	1195	5,381	7,174	8,968	10,762	12,555
KS 1.150	1030	1360	6,192	8,256	10,319	12,383	14,447
KS 1.160	1030	1525	7,002	9,337	11,671	14,005	16,339
KS 1.170	1030	1690	7,813	10,418	13,022	15,627	18,231
KS 1.180	1030	1855	8,624	11,499	14,373	17,248	20,123
KS 1.190	1030	2020	9,435	12,580	15,725	18,870	22,015
KS 1.191	1030	2185	10,246	13,661	17,076	20,491	23,907
KS 1.192	1030	2350	11,057	14,742	18,428	22,113	25,799
KS 1.200	1195	1030	5,399	7,198	8,998	10,797	12,597
KS 1.210	1195	1195	6,356	8,475	10,594	12,713	14,832
KS 1.220	1195	1360	7,314	9,752	12,191	14,629	17,067
KS 1.230	1195	1525	8,272	11,030	13,787	16,544	19,302
KS 1.240	1195	1690	9,230	12,307	15,383	18,460	21,537
KS 1.250	1195	1855	10,188	13,584	16,980	20,376	23,771
KS 1.260	1195	2020	11,146	14,861	18,576	22,291	26,006
KS 1.270	1195	2185	12,103	16,138	20,172	24,207	28,241
KS 1.280	1195	2350	13,061	17,415	21,769	26,123	30,476
KS 1.290	1360	865	4,989	6,651	8,314	9,977	11,640
KS 1.291	1360	1030	6,227	8,303	10,379	12,455	14,530
KS 1.292	1360	1195	7,332	9,776	12,220	14,664	17,108
KS 1.300	1360	1360	8,437	11,249	14,062	16,874	19,686
KS 1.31	1360	1525	9,542	12,722	15,903	19,084	22,264
KS 1.32	1360	1690	10,647	14,196	17,744	21,293	24,842
KS 1.33	1360	1855	11,751	15,669	19,586	23,503	27,420
KS 1.34	1360	2020	12,856	17,142	21,427	25,713	29,998
KS 1.35	1360	2185	13,961	18,615	23,269	27,922	32,576
KS 1.36	1360	2350	15,066	20,088	25,110	30,132	35,154
KS 1.369	1525	2845	20,826	27,768	34,711	41,653	48,595
KS 1.37	1525	1360	9,560	12,746	15,933	19,119	22,306
KS 1.38	1525	1525	10,811	14,415	18,019	21,623	25,227
KS 1.39	1525	1690	12,063	16,084	20,106	24,127	28,148
KS 1.40	1525	1855	13,315	17,754	22,192	26,630	31,069
KS 1.41	1525	2020	14,567	19,423	24,278	29,134	33,990
KS 1.42	1525	2185	15,819	21,092	26,365	31,638	36,911
KS 1.43	1525	2350	17,071	22,761	28,451	34,142	39,832
KS 1.44	1690	1525	12,081	16,108	20,135	24,162	28,189
KS 1.45	1690	1690	13,480	17,973	22,467	26,960	31,453
KS 1.46	1690	1855	14,879	19,839	24,798	29,758	34,717
KS 1.47	1690	2020	16,278	21,704	27,130	32,556	37,981
KS 1.48	1690	2185	17,677	23,569	29,461	35,353	41,245
KS 1.49	1690	2350	19,076	25,434	31,793	38,151	44,510
KS 1.50	1855	1525	13,351	17,801	22,251	26,702	31,152
KS 1.51	1855	1690	14,897	19,862	24,828	29,793	34,759
KS 1.52	1855	1855	16,443	21,923	27,404	32,885	38,366
KS 1.53	1855	2020	17,988	23,985	29,981	35,977	41,973
KS 1.54	1855	2185	19,534	26,046	32,557	39,069	45,580
KS 1.55	1855	2350	21,080	28,107	35,134	42,161	49,187
KS 1.60	2020	1855	18,006	24,008	30,011	36,013	42,015
KS 1.61	2020	2020	19,699	26,266	32,832	39,398	45,965
KS 1.62	2040	2205	20,982	27,976	34,970	41,963	48,957
KS 1.63	2040	2370	22,675	30,233	37,791	45,349	52,907
KS 1.64	2040	2535	24,368	32,490	40,613	48,735	56,858
KS 1.67	2040	3030	29,446	39,262	49,077	58,892	68,708
KS 1.80	2370	2040	22,639	30,185	37,732	45,278	52,824
KS 1.81	2370	2205	24,626	32,835	41,043	49,252	57,460
KS 1.82	2370	2370	26,613	35,484	44,355	53,226	62,097
KS 1.84	2370	2700	30,587	40,782	50,978	61,173	71,369
KS 1.86	2370	3030	34,561	46,081	57,601	69,121	80,641
KS 1.90	2700	2370	30,551	40,735	50,918	61,102	71,286
KS 1.91	2700	2700	35,113	46,817	58,522	70,226	81,930
KS 1.92	2700	3030	39,675	52,900	66,125	79,350	92,575
KS 1.93	2700	3360	44,237	58,982	73,728	88,474	103,219
KS 1.94	2700	3690	48,799	65,065	81,331	97,597	113,864
KS 1.95	2700	4020	53,361	71,148	88,934	106,721	124,508

## Air Handling Units with Plate Type Heat Recovery Unit

In principle, in plate type air-to-air heat recovery systems, heat transfer is directly made from exhaust air to fresh air such that saving is achieved for indoor load value at heating and cooling conditions.

In heat recovery systems known as plate type, aluminium plates designed to form different flow paths for exhaust air and fresh air are used. Exhaust air and fresh air meet to the heat recovery unit without mixing with each other, and heat transfer is conducted through the aluminium plates. Air handling unit, in which mixed air is not required, is commonly used energy saving systems providing high-efficiency and optimum cost in their designs. Standard plate models are manufactured from aluminium material and there are alternative solutions for inox and epoxy applications for different environments and for fluids with different contents. Efficiency of these units goes up to 70%.

Condensation water produced by warm air during the operation is thrown out. Since this condensation water carries the risk to freeze in winter time applications, and hence to harm the heat recovery unit, while choosing the heat recovery unit, frost risk is controlled and if any risk of frost is detected, by-pass or closing damper unit designs are preferred. In such products, the control of damper motor is done by frost thermostat, so that in case of any frost risk, fresh air is by-passed in order not to pass through plates.

In 100% fresh air units or (in case of need) in mixed air units, plate type heat recovery units can be used. Depending on the mixture ratio of fresh air, plate type heat recovery air handling units with different configurations can be designed. Design of the unit can be at different alternatives depending on internal and external weather conditions and application details of air handling unit.

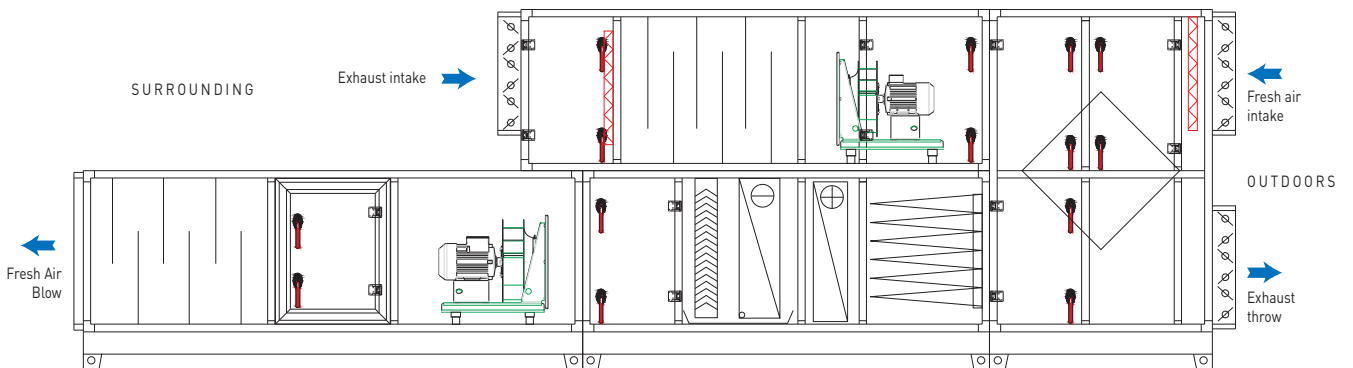
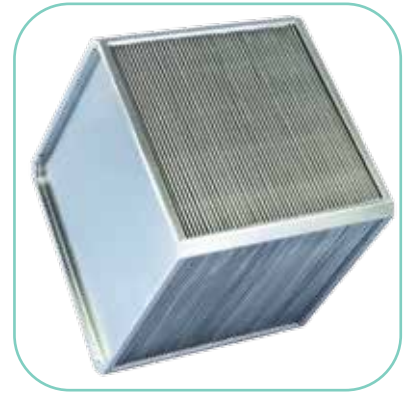
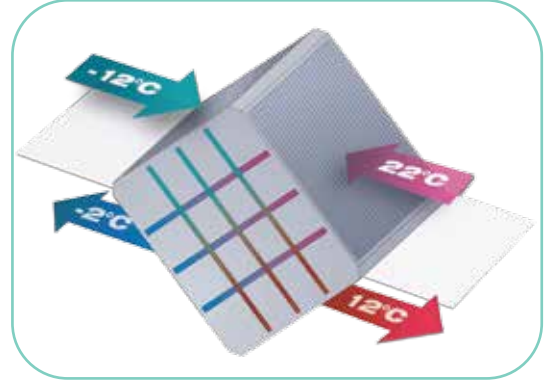

# Air Handling Unit

## Air Handling Units with Rotary Type Heat Recovery Unit

In principle, in rotary type air-to-air heat recovery systems, heat transfer is directly made from exhaust air to fresh air such that saving is achieved for indoor load value at heating and cooling conditions.

Heat recovery units known as rotary type, are formed by aluminium plates placed on top of each other, such that air stream in between is allowed when plates are overlapping. In such heat recovery units, efficiency values ranging from 50% to 85% can be achieved depending on operation conditions. Considering today's energy costs, usage of these rotary heat recovery units with higher energy saving capabilities are getting more common day by day. Moreover, since the frost risk in rotary type unit is much lower than plate type unit, in case of frequent operation in winter conditions, rotary heat recovery units are commonly used in air handling unit preferences.

Although it is possible to have up to 2-4% unintended mixture leakage because of mounting and application preferences, rotary type units are preferred in projects due to their high-efficiency. Furthermore, mixture leakage can be arranged such that its direction is towards exhaust air from fresh air, by custom construction design and measures to be taken.

While air handling units with rotary type heat recovery provide alternative to epoxy applications, they can also be produced in configurations with condensation or enthalpy rotor.

In 100% fresh air units or (in case of need) in mixed air units, rotary type heat recovery units can be used. Depending on the mixture ratio of fresh air, rotary type heat recovery air handling units with different configurations can be designed. Design of the unit can be at different alternatives depending on internal and external weather conditions and application details of air handling unit.

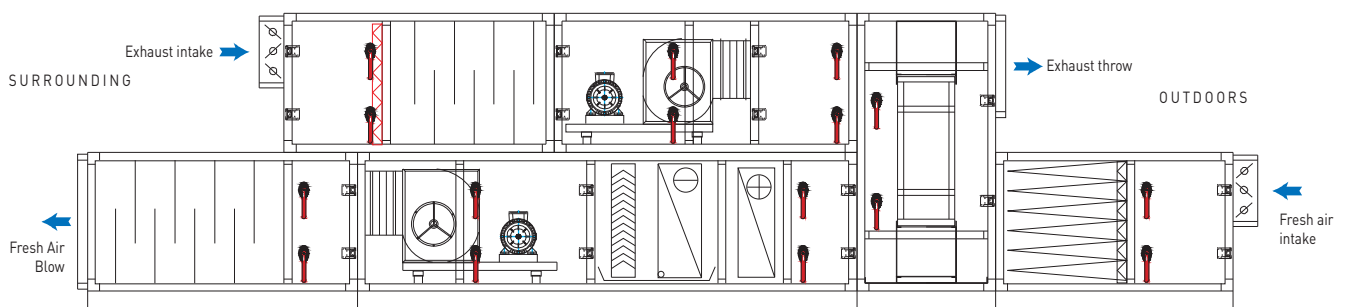
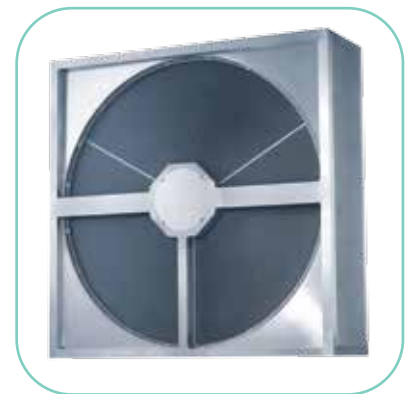
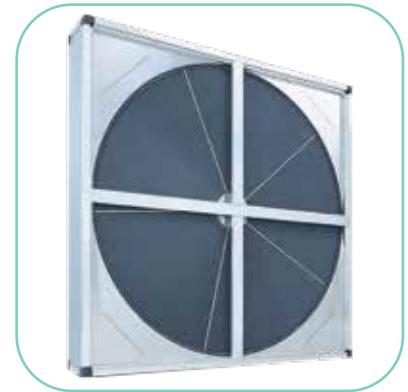



## Hygienic Air Handling Units

Internal surfaces of hygienic air handling units are coated with stainless steel sheet. Before coating the internal surfaces, the unit is washed for purification; and during this process, an anti-bacterial silicone is applied to the bottom surface for water impermeability. Moreover, the base placed under the units is produced as high as needed for siphon applications.

In hygienic air handling units, coils are manufactured as epoxy coated and with copper collector. Coil case and sled systems are made from stainless steel sheet.

In order to prevent water accumulation at cell's connection areas, the units are connected with special connectors and then coated with stainless steel sheet such that a flat surface is obtained. In order to enable any kind of washing within the units and prevent any water accumulation and air leakage, special discharging system with siphon is employed in production by default. For visual inspection of the inside of air handling unit during operation, several monitoring windows and waterproof lightings are placed within the cells.

In order to meet the requirements from fans during process correctly, fans are chosen to be backward inclined with seldom wings and such that they can be easily disinfected. Plug fan applications are preferred more often since it enables air flow measurements and accurate setting.

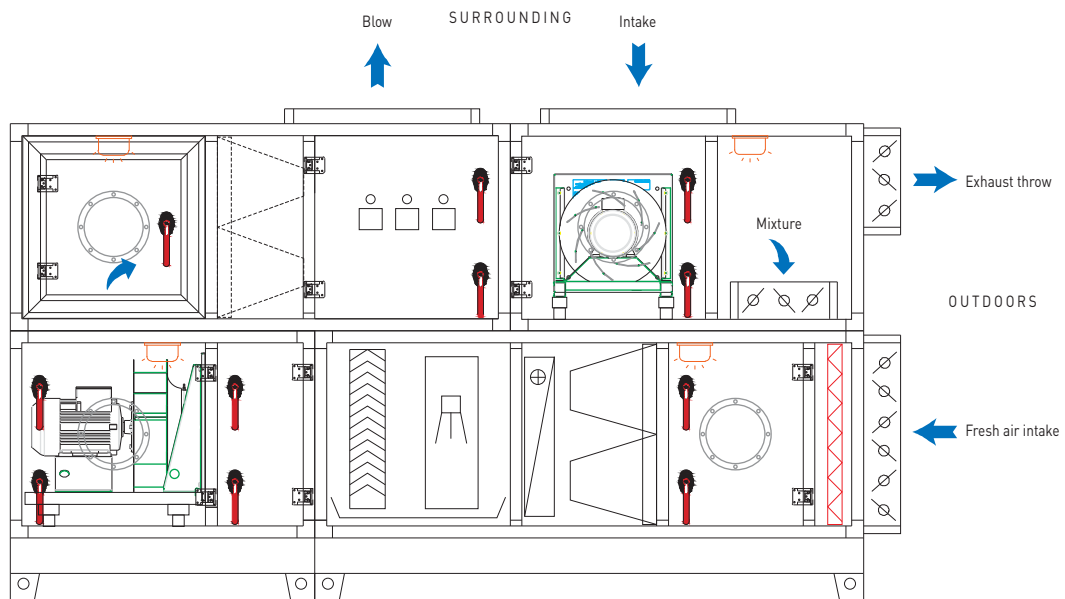

# Air Handling Unit

## Package Hygienic Air Handling Units (PHS)

Internal surfaces of panels of hygienic package type air handling units are manufactured to be covered with stainless sheet. Antibacterial silicon is applied for ensuring impermeability of hygienic air handling units. Units bases are designed with minimum height of 220 mm to be adapted for siphon operation as base + leg for ensuring ease of application.

For hygienic air handling units, coils are manufactured as epoxy coated and with copper collector. Coil frame and guides are manufactured from stainless sheet.

In order to prevent water accumulation at cell junction points of the hygienic air handling units, the units are covered by stainless sheet after being connected via special junctions pieces, and a flat surface is obtained. Hygienic air handling units are manufactured with a flush drain to ensure that water accumulated inside when it's washed for cleaning all parts required to be cleaned is discharged and air leak from outside to inside is prevented. Sight glasses and air-tight lighting fixtures are installed to the cells for performance of visual inspection of air handling unit during operation.

In hygienic air handling units, fans are used with easily disinfected, backward curved blades for correctly meeting the need within the process. Plug fan applications are distinguished by performance of flow rate measurements and precise control.

Models	Air Flow m <sup>3</sup> /h	Aspirator Motor Power kW	Ventilator Motor Power kW	Selected Heating Capacity kW	Selected Cooling Capacity kW	Dimensions				
						A mm	B mm	L mm	C mm	H mm
HYP-PHS-25	2500	1.1	3	37	21	1855	2020	3875	865	1950
HYP-PHS-50	5000	2.2	5.5	59	42	1855	2020	3875	1030	2280
HYP-PHS-75	7500	4	7.5	111	60	2020	2350	4370	1195	2610
HYP-PHS-100	10000	5.5	11	131	80	3010	1855	4865	1360	2940

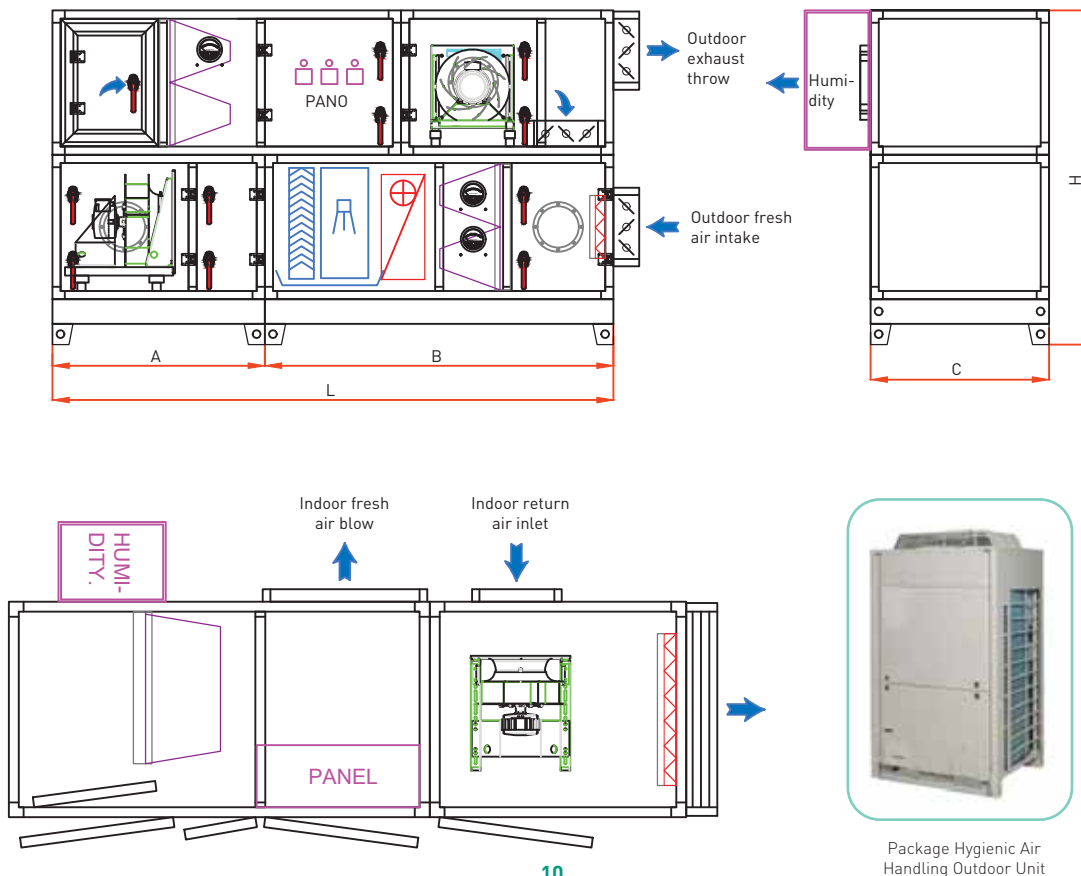

## Air Handling Units Fuelled With Natural Gas (DGS)

In today's technology, heating function in air handling units started to be provided also with natural gas burner systems. Especially in applications where there aren't any hot water, vapour or DX sources or available source capacities aren't sufficient and the required capacity needs are met by natural gas burners built in air handling units.

Air handling units fuelled with natural gas are delivered as a package with automation substructure. Air handling units with natural gas burner are standard air handling units, and meet the heating need with natural gas burner systems, while being able to provide cooling or humidification functions depending on the needs in the application. Air handling units with natural gas burner are manufactured with components with certificates of conformity for required gas directives, and have the required certifications for acquiring project approval from gas distribution companies.

Models	Gas Burner Rated Heating Capacity kW	Air Flow m <sup>3</sup> /h	Minimum Volume m <sup>3</sup> /h	Gas Burner Capacity Control	Gas	Gas Input Pressure mbar	A	B	L	C	H1	LEG +BASE	H
DGS - 18	18	2500	2270	Proportional	G20	20	1690	1030	2720	1030	700	220	920
DGS - 30	30	3500	3290	Proportional	G20	20	1690	1030	2720	1195	700	220	920
DGS - 50	51	4500	3900	Proportional	G20	20	1690	1030	2720	1690	700	220	920
DGS - 60	61	5500	4700	Proportional	G20	20	1690	1030	2720	1525	865	220	1085
DGS - 61	61	7500	7500	Proportional	G20	20	1690	1030	2720	1855	1030	220	1250
DGS - 75	75	7000	5700	Proportional	G20	20	1195	1690	2885	1690	1030	220	1250
DGS - 76	76	9300	9300	Proportional	G20	20	865	2020	2885	2350	1030	220	1250
DGS - 100	100	9000	7500	Proportional	G20	20	1195	2020	3215	2350	1030	220	1250
DGS - 101	100	14000	12400	Proportional	G20	20	865	2020	2885	2350	1030	220	1250
DGS - 120	122	11000	7500	Proportional	G20	20	1690	1195	2885	1855	1030	220	1250
DGS - 125	126	12000	9600	Proportional	G20	20	1360	2020	3380	1690	1360	220	1580
DGS - 150	151	15000	12300	Proportional	G20	20	1360	2020	3380	1690	1690	220	1910
DGS - 152	152	14000	9300	Proportional	G20	20	1195	2020	3215	2350	1030	220	1250
DGS - 175	175	18000	14100	Proportional	G20	20	1360	2020	3380	1690	1855	220	2075
DGS - 199	199	20000	16300	Proportional	G20	20	1360	2020	3380	1690	2020	220	2240
DGS - 200	200	20000	12400	Proportional	G20	20	1195	2185	3380	2350	1195	220	1415
DGS - 250	252	25000	15600	Proportional	G20	20	1195	2020	3215	2350	1360	220	1580
DGS - 300	300	30000	18200	Proportional	G20	20	1195	2020	3215	2350	1690	220	1910

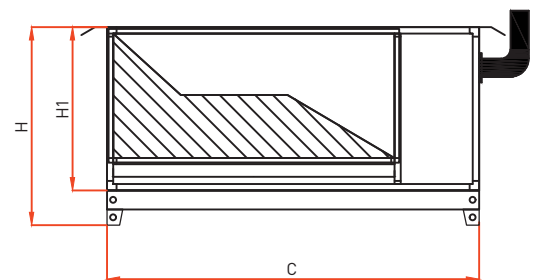
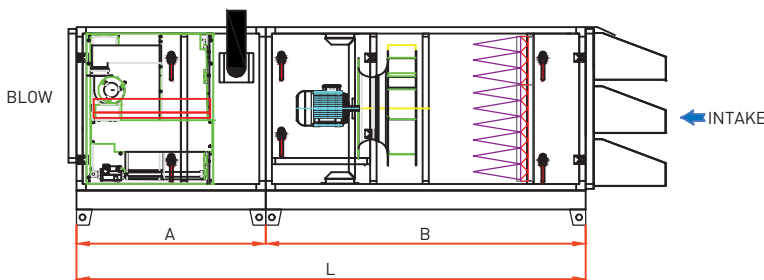

# Air Handling Unit

## Pool Dehumidification Air Handling Units

Pool dehumidification units provide optimal solution for air-conditioning control in indoor swimming pools, SPA and similar health and wellness areas.

Pool dehumidification units can be produced in different capacities such that they can serve a wide range of application areas from a small villa to an olympic swimming pool.

Pool dehumidification units are designed in order to solve the humidity problem in the targeted air-conditioning area with an energy-efficient way.

Pool dehumidification units are served with an automation system and direct expansion cooling circuit.

All cooling circuit and automation device parts are integrated to the air handling device such that humidifying and air-conditioning process work with in the unit.



Models	Air Flow m <sup>3</sup> /h	External Static Pressure Pa	Dehumid- fication Capacity* kg/h	Mixed Dehumidification Capacity** kg/h	Heating Hydrous Coil Capacity kW	Refrigerant	Unit Dimensions	Heat Pipe
VAP 15	1500	300	10	21	35	R407C	3380 x 865 x 1620	R134A
VAP 25	2500	300	15	32	41	R407C	4000 x 1030 x 1400	R134A
VAP 40	4000	300	23	45	63	R407C	4400 x 1200 x 1750	R134A
VAP 45	4500	300	28	53	82	R407C	4400 x 1200 x 1750	R134A
VAP 55	5500	300	33	59	102	R407C	4550 x 1400 x 2100	R134A
VAP 85	8500	300	51	85	119	R407C	5000 x 1360 x 2500	R134A
VAP 100	10000	300	60	102	158	R407C	5000 x 1525 x 2500	R134A
VAP 125	12500	300	73	123	280	R407C	4865 x 2390 x 1690	R134A
VAP 150	15500	300	90	152	280	R407C	5030 x 1855 x 2720	R134A
VAP 200	20000	300	102	184	380	R407C	5690 x 2020 x 3050	R134A
VAP 250	25000	300	118	214	380	R407C	5400 x 2350 x 3050	R134A
VAP 300	30000	300	148	266	480	R407C	4905 x 2370 x 3540	R134A

\* Heat-Pipe efficiency is not included in humidity content detected in indoor air circulation on 30°C 50-55% Rh conditions. Outdoor air is not included (Winder and Night mode)

\*\* 30% fresh air mixture in +5°C outdoor temperature and Heat-Pipe included dehumidification capacity.

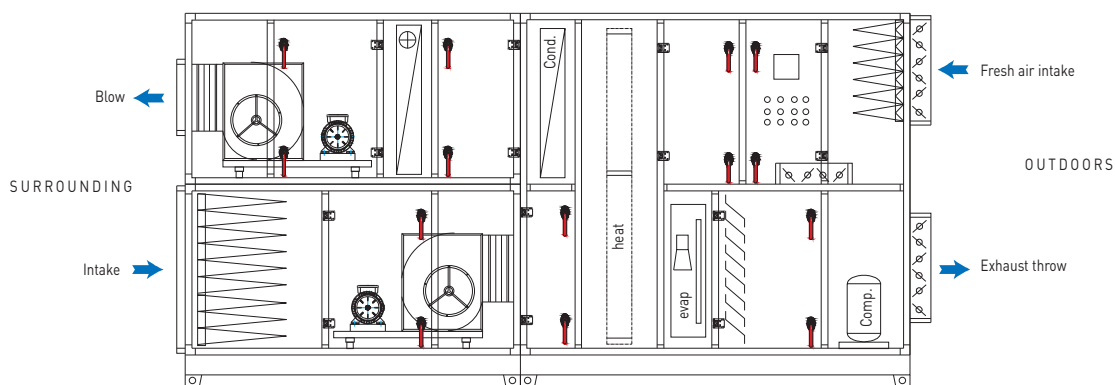

## Duct Type Air Handling Units (Vertical or Horizontal Type)

Duct type air handling units are designed in order to correspond the requirement of heating, cooling, air conditioning in small-to-mid size building sections with ergo dynamic sized units in special architectural applications.

Depending on the architectural design of building, it can be employed within suspended ceiling as horizontal type or within cabinets as vertical type.

Duct type air handling units are served in 5 main unit sizes providing an air flow within the range of 1500 m<sup>3</sup>/h to 7000 m<sup>3</sup>/h.

Duct type air handling units are manufactured with plug fans with backward curved blades. Optional package automation system for duct type air handling units can be provided upon request. Since duct type air handling units are commonly mounted very close to daily living environments, the sound levels are intentionally designed to be very low.

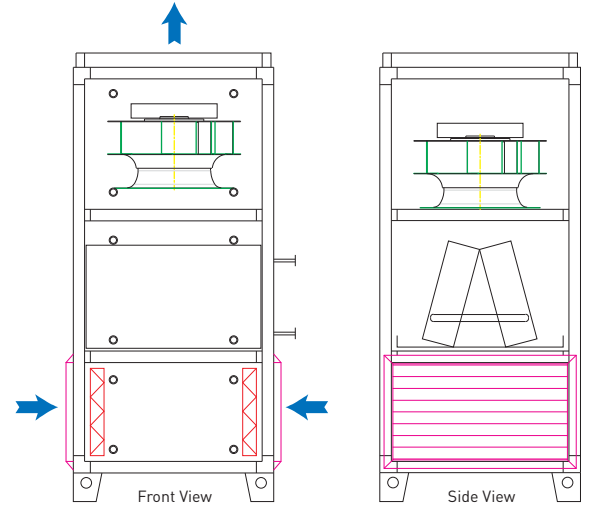

# Air Handling Unit

## Shelter-Ventilating Units (SKS)

Ventas Shelter ventilating compact handling units are produced in eight models between 300 and 4000 m<sup>3</sup>/h capacities. Since they have a more compact structure compared to standard handling units cell structures, connection to air channel on the ceiling is possible. It has all qualities that a cellular type shelter ventilation unit has.

Shelter ventilating unit principally works in two different ways. Normally, fresh air is sent to the shelter through a G-4 panel filter. During war time, fresh air passes through an active carbon filter and a hepa filter that can absorb nuclear, biological and chemical gasses.

For capacities over 4000 m<sup>3</sup>/h, shelter ventilation units are produced with standard air handling unit modelling.

Models	Air Flow m <sup>3</sup> /h	External Pressure Pa	Total Installed Power W	Supply	A mm	B mm	C mm	D mm	E mm
SKS300	300	215	155	220 V	1135	398	516	338	456
SKS500	500	195	210	220 V	1135	398	516	338	456
SKS800	800	235	225	220 V	1135	398	945	338	885
SKS1200	1200	273	515	220 V	1135	398	945	338	885
SKS1500	1500	148	515	220 V	1135	398	945	338	885
SKS2000	2000	215	1030	220 V	1335	398	1133	338	1073
SKS3000	3000	85	1030	220 V	1335	550	1133	490	1073
SKS4000	4000	45	1100	220 V	1635	704	1510	644	1450

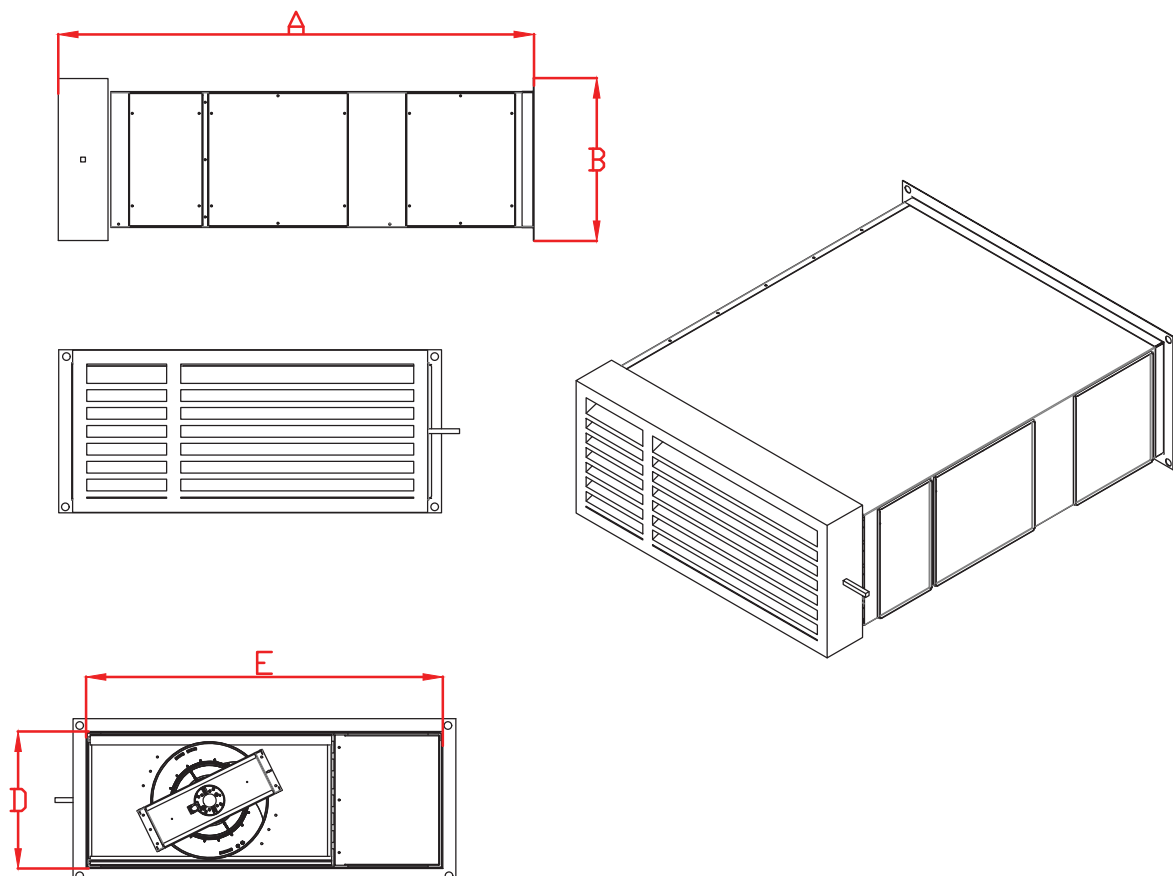



## Ventas Isıtma, Soğutma, Enerji Sistemleri, İnşaat San. ve Tic. A.Ş.

### Ventas Headquarters

Ortaklar Cd. Denizhan Sk. Lale Han No:7 Kat:2  
Mecidiyeköy Şişli, İstanbul, Turkey  
T: +90 212 216 05 16 • F: +90 212 216 05 14

### Ventas Hadımköy Facility

Alkop Alüminyumcular Sanayi Sitesi C1 Blok  
No:1-2-3-4-5, 34500 Esenyurt, İstanbul, Turkey  
T: +90 212 858 12 82 • F: +90 212 858 12 79

### Ventas Catalca Facility

Çakıl Mh. Elbasan Cd. No: 126/A 34540  
Çatalca, İstanbul, Turkey  
T: +90 212 858 12 82 • F: +90 212 858 12 79

**Ankara Regional Office:** Aziziye Mahallesi Kırkpınar Sokak No: 10/5 Çankaya, Ankara, Turkey • T: 0312 439 59 50 • F: 0312 439 59 50

**Bursa Regional Office:** Alaaddinbey Mh. Pazar Cd. No:27 A/C Nilüfer, Bursa, Turkey • T: +90 224 441 03 66 • F: +90 224 441 03 67

**Diyarbakır Regional Office:** Kayapınar Mah. Gap Bulvarı Peyas 1 Sok. No:1 A Blok Kayapınar, Diyarbakır, Turkey • T: +90 412 251 51 45 • F: +90 412 251 51 45

**Konya Regional Office:** Fevzi Çakmak Mahallesi 10670 Sokak 27/B Karatay, Konya, Turkey • T: +90 332 236 22 64 • F: +90 332 236 73 56

[www.ventas.com.tr](http://www.ventas.com.tr)